



Sfera Keypad Module

User and installation manual

bticino



Contents

General information	4
Warnings and recommendations	5
Regulatory warnings	5
Front view	6
Back view	7
Installation	8
Mounting	8
Disassembling	10
Use of the device	12
Door lock control	12
Door lock control with stand-alone Keypad Module 353000	12
Door lock control with Sfera Speaker Module 351100/351200/351300 and Keypad Module 353000	12
Direct call with Sfera Speaker Module 351100/351200/351300 and Keypad Module 353000	13
Device configuration	14
Administrator code	14
New administrator code	14
Deleting administrator codes	17
Passepartout code	18
New passepartout code	18
Deleting administrator codes	21
Replacement of passepartout codes	22
Resident code	24
New resident code	24
Deleting resident codes	27
Replacing resident codes	29
Reset	31
Configuration using the software	32
Connection to the PC	32

General information

The Sfera Keypad Module must be used only on BTicino 2 wires digital systems.

Finishes that can be associated to the BTicino Sfera Keypad Module:



Front cover 353005



Front cover 353001/02/03



Front cover 353011

Warnings and recommendations

It is important to read this manual carefully before proceeding with the installation. The warranty becomes automatically void in case of negligence, improper use, tampering by unauthorised personnel.

Regulatory warnings



Read carefully before use and keep for future reference



Touching the units with wet hands is forbidden
Using liquid cleaners or aerosols is forbidden
Blocking the ventilation openings is forbidden
Modifying the devices is forbidden
Removing protective parts from the devices is forbidden
Installing the units near liquids and powders is forbidden
Installing the units near heat sources is forbidden
Installing the units near harmful gases, metal dusts or similar is forbidden
Fastening the units on unsuitable surfaces is forbidden



Risk of devices falling because the surface on which they are installed collapses or inappropriate installation.
Switch the power supply OFF before any work on the system



Caution: Installation, configuration, starting-up and maintenance must be performed exclusively by qualified personnel.
Check that the wall installation has been carried out correctly
Lay out the wires respecting the standards in force
Connect the power supply wires as indicated
Use only the items indicated in the technical specifications for any system expansions

Front view

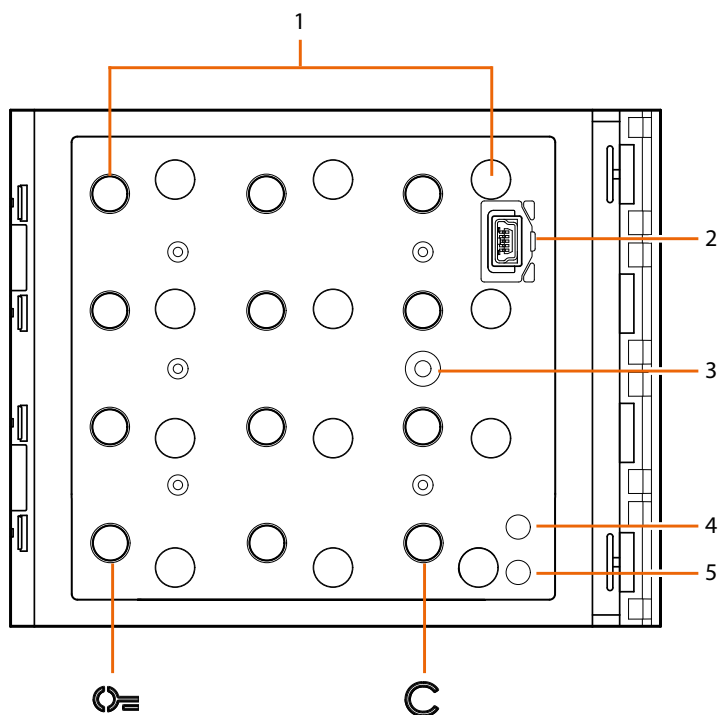

1. Digital keypad + key illumination LED.
☰ key for the selection of the door lock release code
C key for the replacement of the codes.
2. Mini-USB programming connector.
3. Programming pushbutton..
4. Red LED on steady: access denied, or programming error
5. Green LED on steady: access granted, or programming successful

Back view

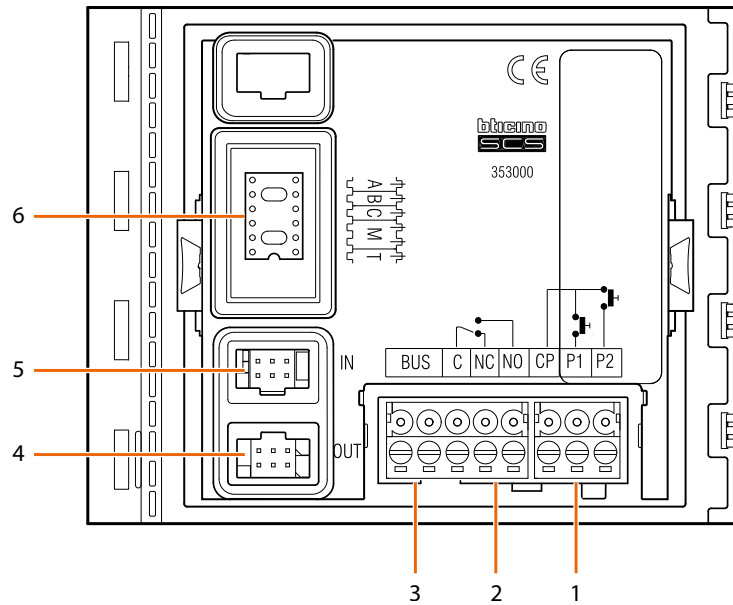

1. Connection of door lock pushbutton (CP-P1) and tamper (CP-P2 – future application).
2. Local relay contacts.
3. Connection to the BUS.
4. Connector for the connection to subsequent modules.
5. Connector for the connection to previous modules.
6. Configurator sockets.

Installation

Mounting

 Caution: Installation, configuration, starting-up and maintenance must be performed exclusively by qualified personnel.

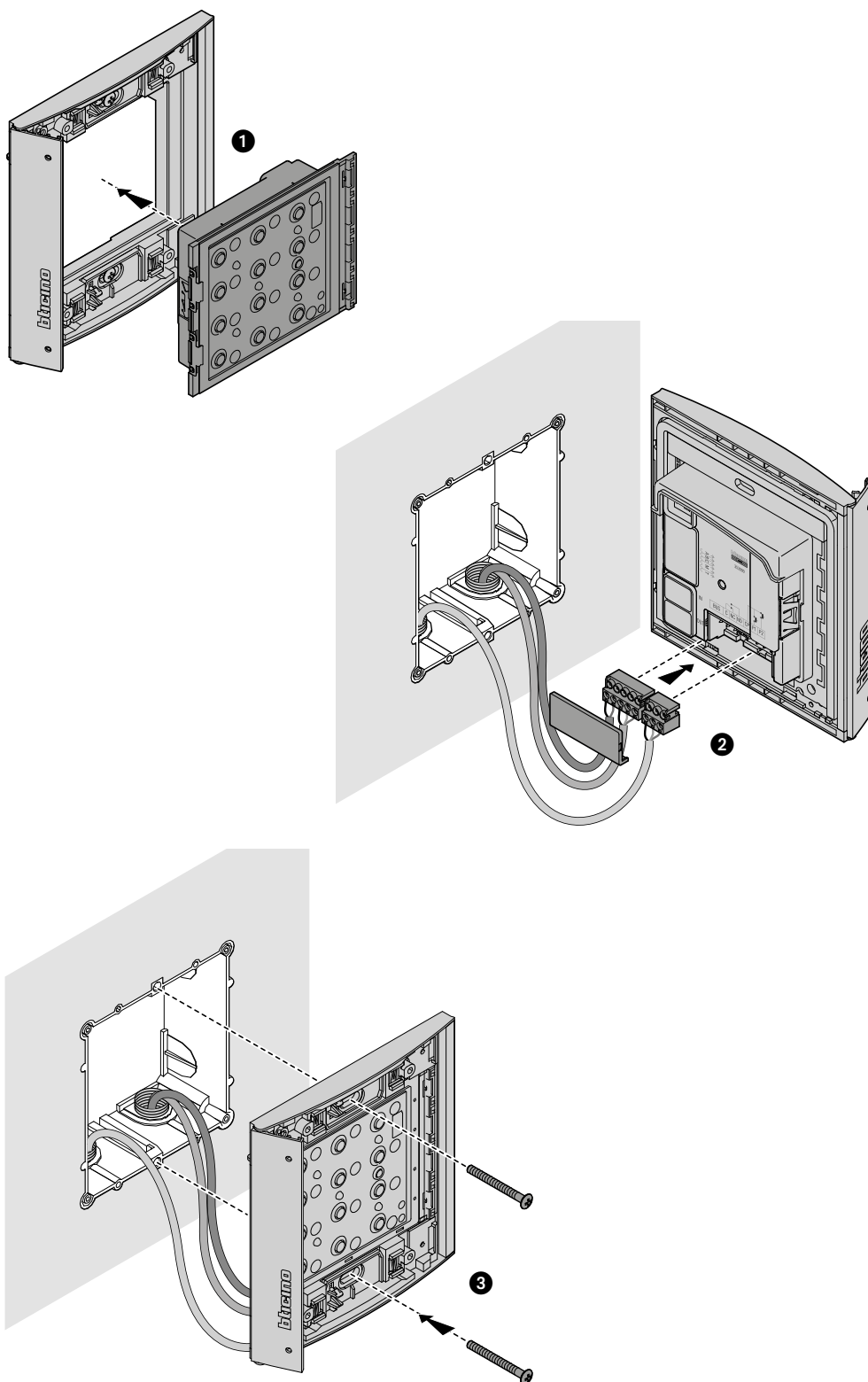

Sfera Keypad Module

User and installation manual

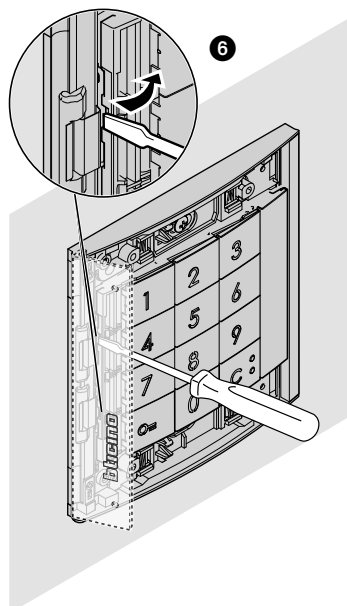
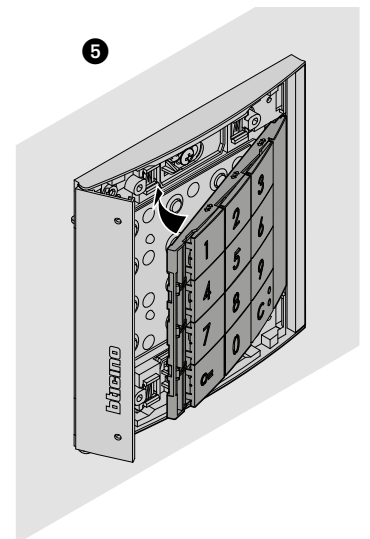
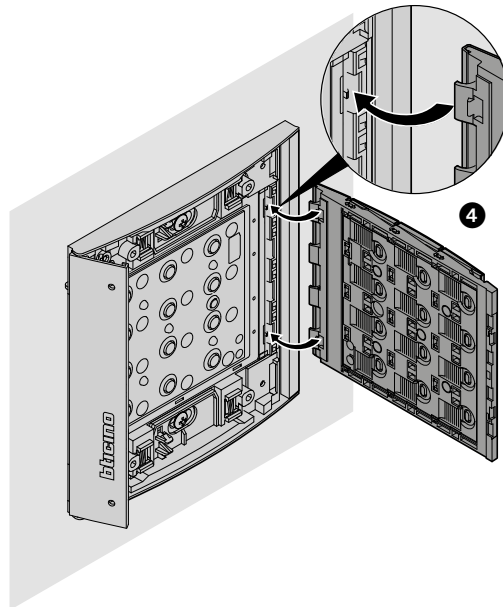

Sfera Keypad Module

User and installation manual

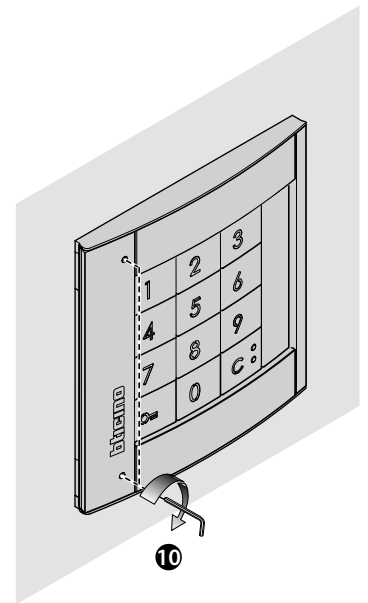
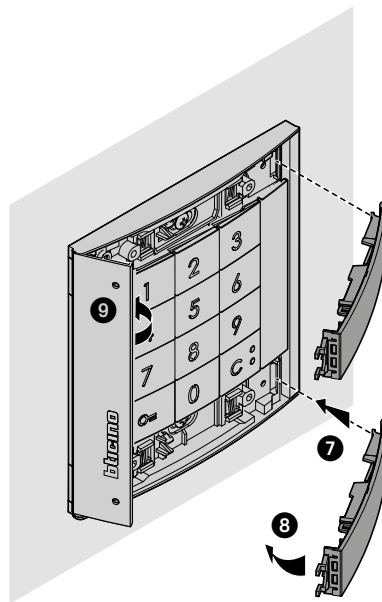

Disassembling

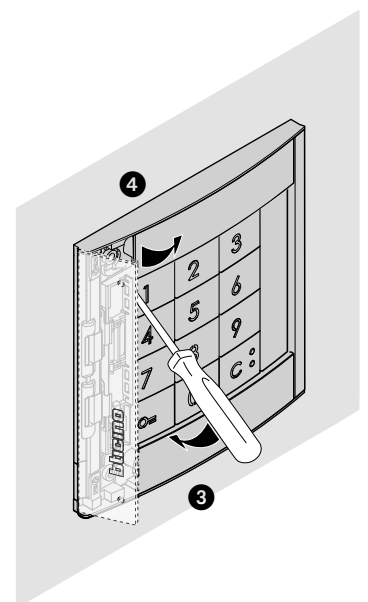
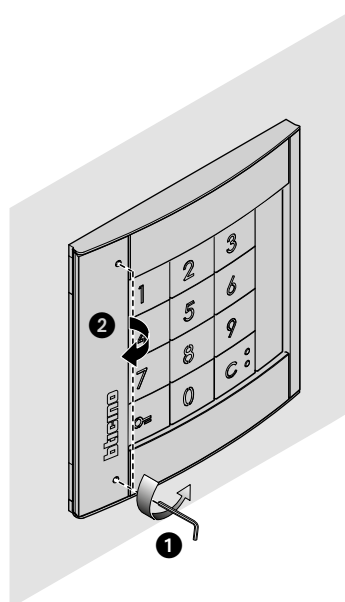

Sfera Keypad Module

User and installation manual

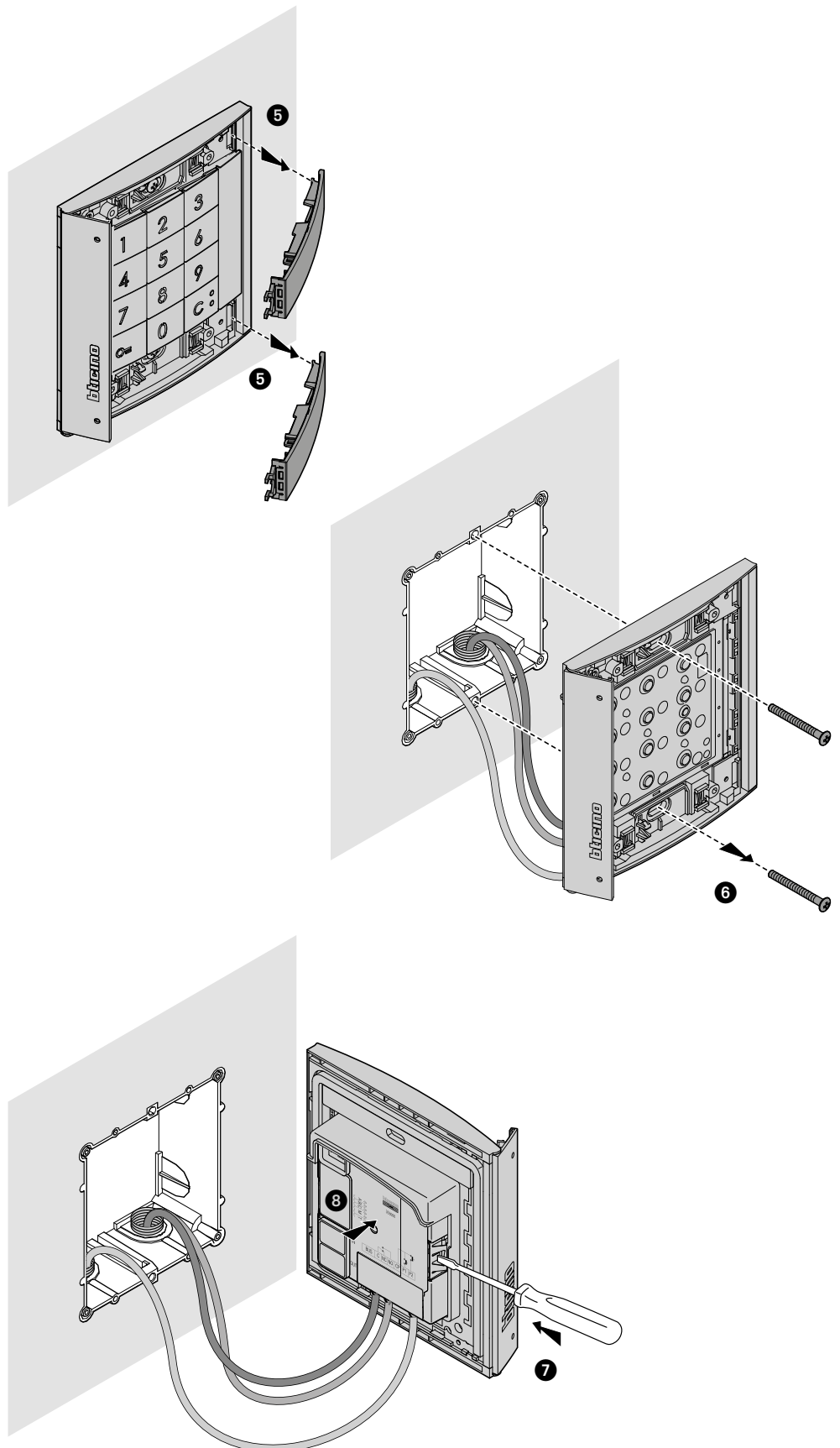

Use of the device

The BTicino Sfera Keypad Module allows residents to open a door lock through the recognition of previously stored numerical codes.

The device consists of a backlit pushbutton panel with 12 keys and LEDs to control the correct entry of the code.

When combined with speaker module item 351100/351200/351300 and appropriately configured, it also allows direct call.

Note: This manual refers to the Sfera wired stand-alone Keypad Module or paired with the Sfera Speaker Module (351100/351200/351300).

If the Sfera Keypad Module is installed linked to the Display Module (352500) refer to the Display manual for the code programming.



Caution: the secret code must consist of a minimum of 4 to a maximum of 9 digits.

Door lock control

The TiSferaDesign software can be used to set the maximum number of digits of the code (min. 4 to max. 9).

Entering the codes to open the door lock varies depending on the code length (if it is shorter than or the same as the maximum set) and the type of installation.

The correct form to use in the specific cases is shown in the tables below.

Door lock control with stand-alone Keypad Module 353000

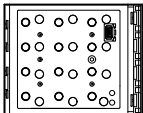
STAND-ALONE KEYPAD MODULE	DOOR LOCK	SHORT OPENING CODE	MAX. OPENING CODE
	Door lock connected to the C/NO/NC local relay of the keypad module	○= 12345 ○=	○= 123456789

Door lock control with Sfera Speaker Module 351100/351200/351300 and Keypad Module 353000

The link between a Sfera Speaker Module and the Keypad Module allows the management of two door locks. The table below shows how to use the codes correctly.

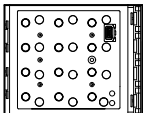
SPEAKER MODULE + KEYPAD MODULE	DOOR LOCK	SHORT OPENING CODE	MAX. OPENING CODE
	Door lock connected to the S+ S- contact of the speaker module	○= 12345 ○=	○= 123456789
	Door lock connected to the C/NO/NC local relay of the keypad module*	○= ○= 12345 ○=	○= ○= 123456789

*To use this function, make sure that the keypad module is configured with M=3 or M=23

Note: the local relay closing time of the Keypad module is 4" and cannot be modified.

Direct call with Sfera Speaker Module 351100/351200/351300 and Keypad Module 353000

Linking the Sfera Speaker Module and the Keypad Module allows direct call to an internal unit using the code. **Enter the call code, 1 to 4 digits, between 0 and 3999.** The table below shows how to use the codes correctly.

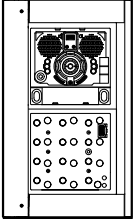
SPEAKER MODULE + KEYPAD MODULE	CALL CODE
	1234C

To use this function, make sure that the keypad module is configured with M=20 or M=23

Device configuration

The configuration can be performed in two ways:

- using the [TiSferaDesign software](#)
- following specific procedures using the [keypad](#)

For the configuration of the administrator codes, remove the front cover and press the programming button highlighted in the legend.

It is possible to program three different types of codes:

ADMINISTRATOR Code granting access to the programming of the other codes. This code has programming rights, but not access rights..

PASSEPARTOUT This code allows the opening of the door lock to which the entrance panel is associated.

It is not connected with any apartments.

This code has access rights, but no programming rights.

RESIDENTS This code allows the opening of the door lock to which the entrance panel is associated.

It's linked to an apartment of the system.

This code has access rights, but no programming rights.

Ha solo diritto di accesso e non di programmazione.

Administrator code

The "ADMINISTRATOR" code is required for safety reasons, and is directly programmed by the installer. The code grants access to the programming of the other codes (passepartout and residents).

In order to access programming mode, it will be necessary to assign an administrator code to the device. It is possible to save up to 20 administrator codes.

The keypad module will indicate if the code is accepted or rejected through audible signals and the switching on of the green LED. Entering an unrecognised code will cause the interruption of the programming procedure. This interruption will be notified with an extended beep and the switching on of the red LED.

Note : only with Sfera Speaker Module 351100/351200/351300 + the associated Sfera Pushbutton Modules 352000/352100 or only with the Sfera Keypad Module.

New administrator code



1. Press and hold down the programming pushbutton until the green LED starts flashing and a confirmation tone is heard..
2. Press the key

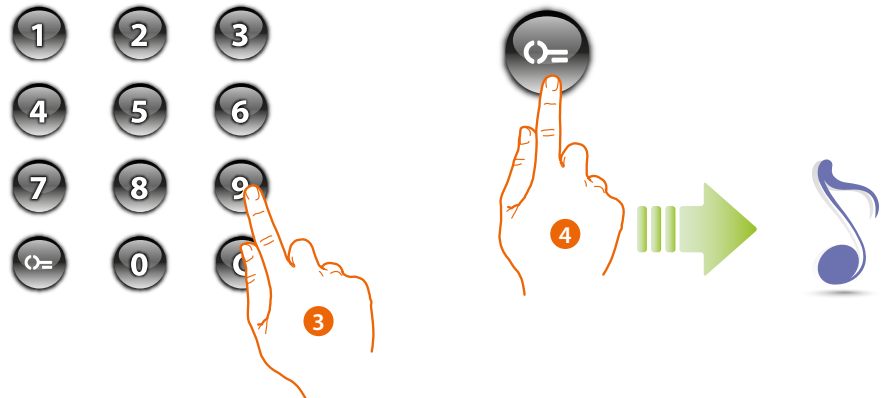

3. Enter the code (4 to 9 digits).
4. Press the  key
A short beep confirms the programming of the new administrator code.



 12345 

5. Re-enter the code to confirm



Exact code: Green LED ON and short beep.



Wrong code: Red LED ON and long beep.

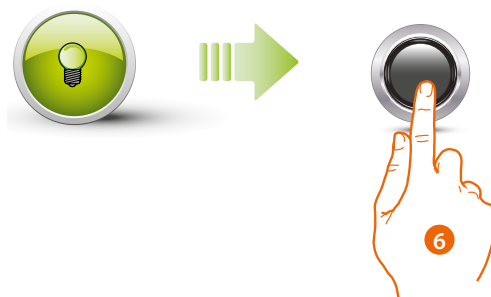

6. If the procedure is successful, the green LED stays on for approximately 1 second and then starts flashing again.
Enter another code or end the procedure.
Press and quickly release the programming pushbutton, or wait 30 seconds to exit the programming procedure.
A short beep and the switching off of the LED indicates that the programming sequence is complete.
The Sfera Keypad module is ready for normal operation.

- During the programming procedure, it will be necessary to follow some rules:
- keys must be pressed in succession (with maximum 2 seconds in between pressures).
 - the programming sequence must start within 30 seconds from the pressure of the programming button, and must be completed in one stage.

Deleting administrator codes

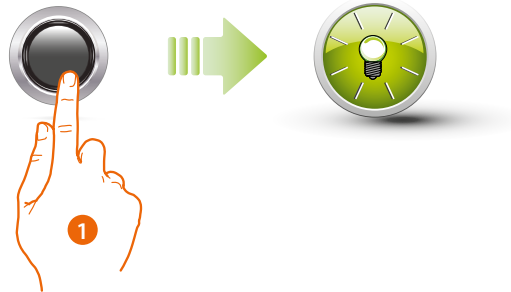

1. Press and hold down the programming pushbutton; the green LED starts flashing.

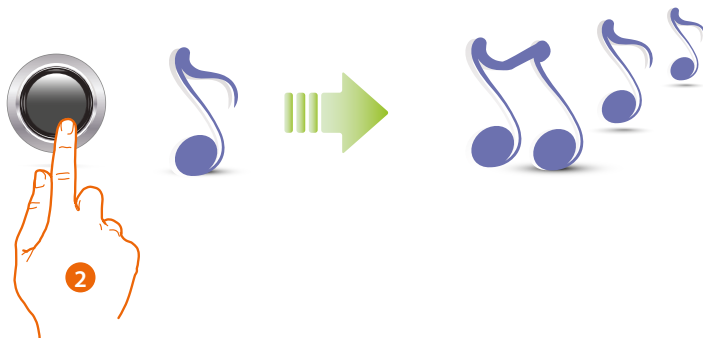

2. **Press and hold down the button;** the device emits 1 beep per second and a long beep after 10 seconds.



The red LED flashes and then switches on to confirm that the deletion is complete.

- ! The procedure will cancel all the saved administrator codes. Press and hold down the programming button during the whole procedure. To stop the deletion procedure release the programming pushbutton. For selective deletion use the TiSferaDesign software.

Passepartout code

To access the programming of a "Passepartout" code, it will be necessary to have an administrator code; it is possible to program up to 20 passepartout codes.

The keypad module will indicate if the code is accepted or rejected through audible signals and the switching on of the green LED. Entering an unrecognised code will cause the interruption of the programming procedure. This interruption will be notified with an extended beep and the switching on of the red LED.

Note : only with Sfera Speaker Module 351100/351200/351300 + the associated Sfera Pushbutton Modules 352000/352100 or only with the Sfera Keypad Module.

New passepartout code

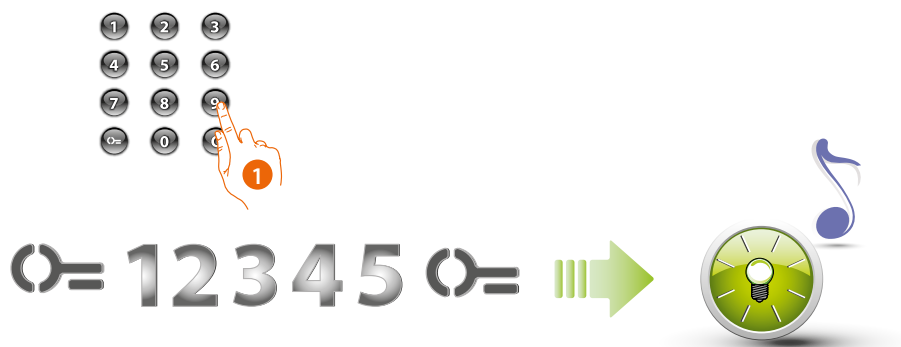

1. **Enter the administrator code.**
The device emits a confirmation beep and the green LED flashes The programming stage has started.

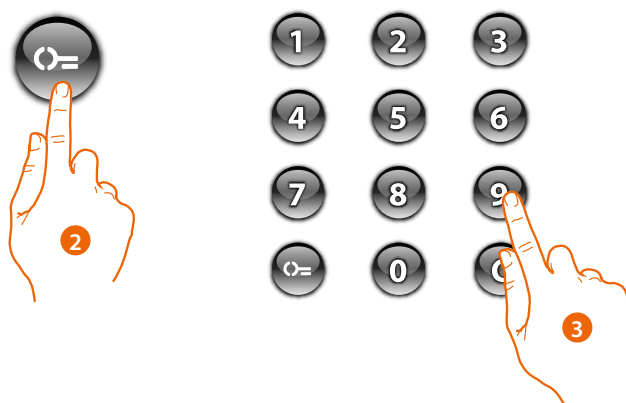

2. Press the key
3. Enter the passepartout code (4 to 9 digits)

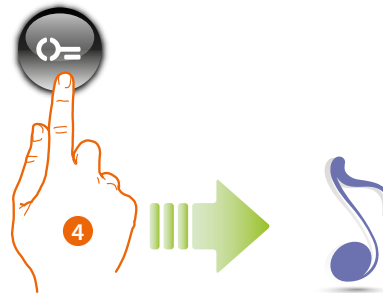

4. Press the  key
A short sound confirms the programming of the new passepertout code.



 1 2 3 4 5 

5. Re-enter the code to confirm



Exact code: Green LED ON and short beep.



Wrong code: Red LED ON and long beep.

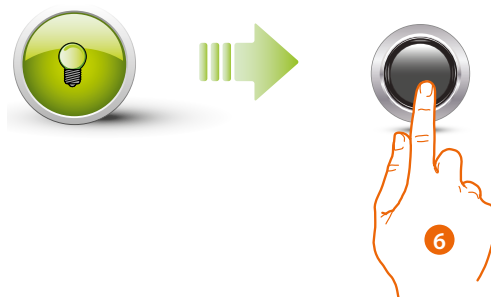

6. If the procedure is successful, the green LED stays on for approximately 1 second and then starts flashing again.
Enter another code or end the procedure.
Press and quickly release the programming pushbutton, or wait 30 seconds to exit the programming procedure.
A short beep and the switching off of the LED indicates that the programming sequence is complete.
The Sfera Keypad module is ready for normal operation.



During the programming procedure, it will be necessary to follow some rules:

- keys must be pressed in succession (with maximum 2 seconds in between pressures).
- the programming sequence must start within 30 seconds from the pressure of the programming button, and must be completed in one stage.

Deleting administrator codes

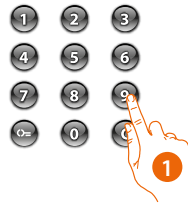

☎= 12345 ☎=

Three times

1. **Enter the administrator code three times in a row.** The device emits a long confirmation beep.



The red LED flashes and then switches on to confirm that the deletion is complete.

- ! The procedure will cancel all the saved Passepartout codes.
For selective deletion use the TISferaDesign software.

Replacement of passepartout codes

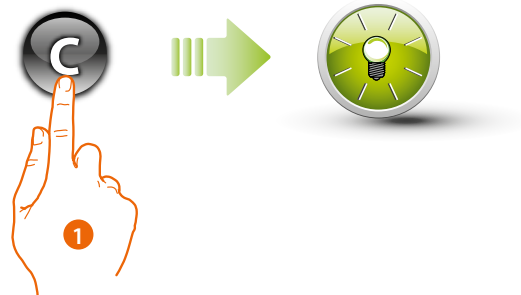

1. Press **C** until the green LED starts flashing.



2. Enter the passepartout code

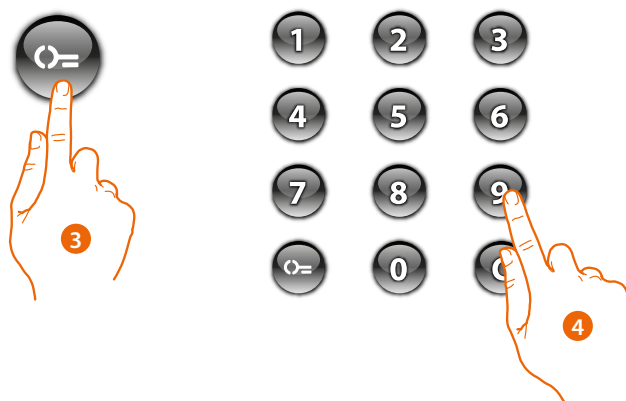

3. Press the **key** icon key
4. Enter the **new code**

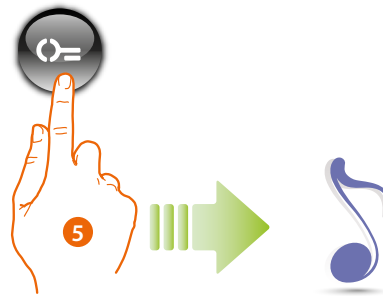

5. Press the  key
A short sound confirms the programming of the new passepartout code.



6. Enter the code again to confirm. The device emits a long confirmation beep.

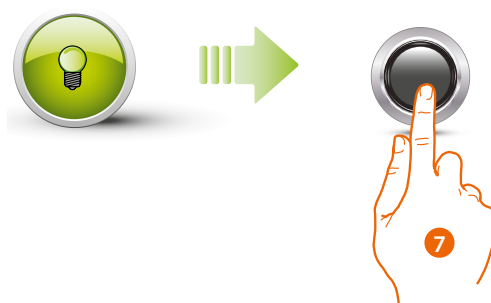

7. If the procedure is successful, the green LED stays on for approximately 1 second and then switches off.



During the programming procedure, it will be necessary to follow some rules:

- keys must be pressed in succession (with maximum 2 seconds in between pressures).
- the programming sequence must start within 30 seconds from the pressure of the programming button, and must be completed in one stage.

Resident code

To access the programming of a "RESIDENT" code, it will be necessary to have an administrator code. It is possible to store up to 4000 codes, one for each apartment.

The keypad module will indicate if the code is accepted or rejected through audible signals and the switching on of the green LED. Entering an unrecognised code will cause the interruption of the programming procedure. This interruption will be notified with an extended beep and the switching on of the red LED.

Note : only with Sfera Speaker Module 351100/351200/351300 + the associated Sfera Pushbutton Modules 352000/352100.

New resident code

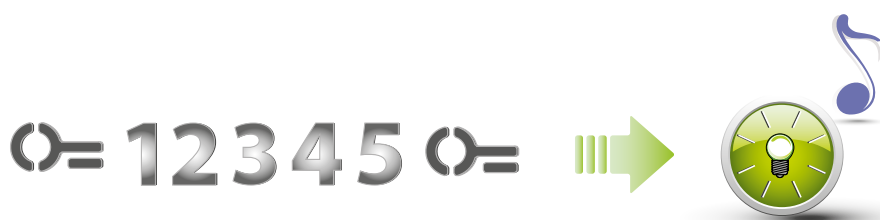

1. Enter the administrator code.

The device emits a confirmation beep and the green LED flashes. The programming stage has started.

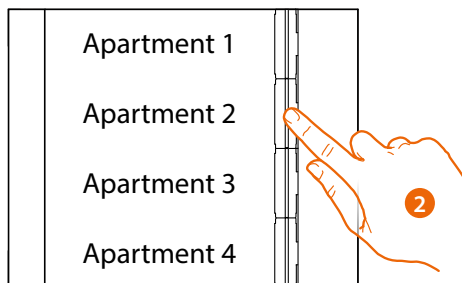

352041/42/43

2. Using the pushbutton module (352000 and 352100), select the apartment to which to associate the resident code.

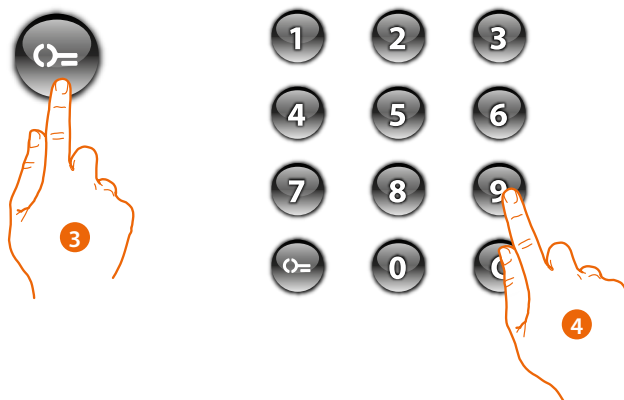

3. Press the key

4. Enter the resident code (4 to 9 digits).

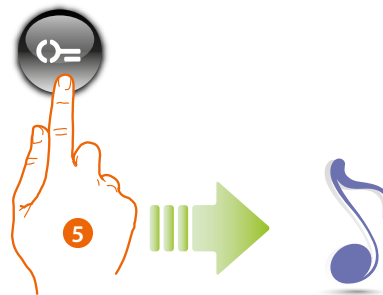

5. Press the 
 A short beep confirms the programming of the new resident code.



 1 2 3 4 5 

6. Re-enter the code to confirm



Exact code: Green LED ON and short beep.



Wrong code: Red LED ON and long beep.

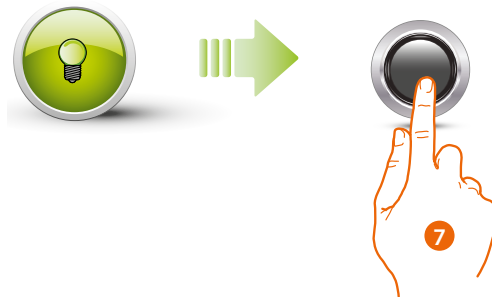

7. If the procedure is successful, the green LED stays on for approximately 1 second and then starts flashing again.
Press and quickly release the programming pushbutton, or wait 30 seconds to exit the programming procedure.
A short beep and the switching off of the LED indicates that the programming sequence is complete.
The Sfera Keypad module is ready for normal operation.



During the programming procedure, it will be necessary to follow some rules:

- keys must be pressed in succession (with maximum 2 seconds in between pressures).
- the programming sequence must start within 30 seconds from the pressure of the programming button, and must be completed in one stage.

Deleting resident codes

Note : only with Sfera Speaker Module 351100/351200/351300 + the associated Sfera Pushbutton Modules 352000/352100.



1. Enter the administrator code

The device emits a confirmation beep and the green LED flashes. The programming stage has started.

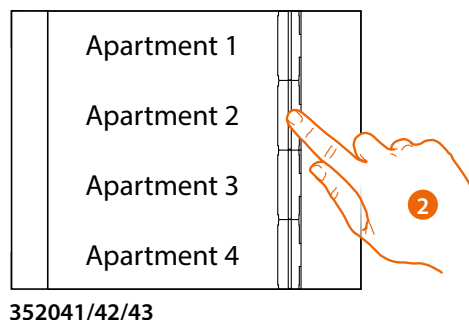

352041/42/43

2. Using the pushbutton module (352000 and 352100), select the apartment associated with the resident code to delete.

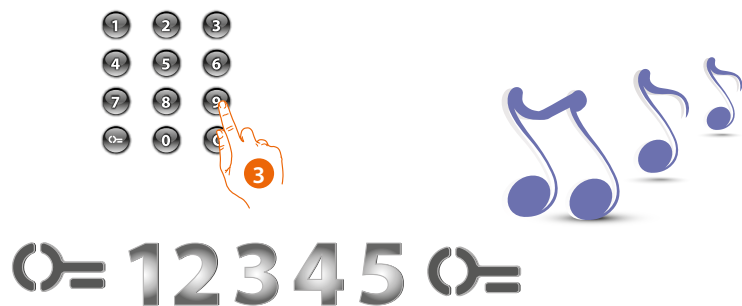

3. Enter the administrator code again to confirm. The device emits a long confirmation beep.



The red LED flashes and then switches on to confirm that the deletion is complete.

Replacing resident codes

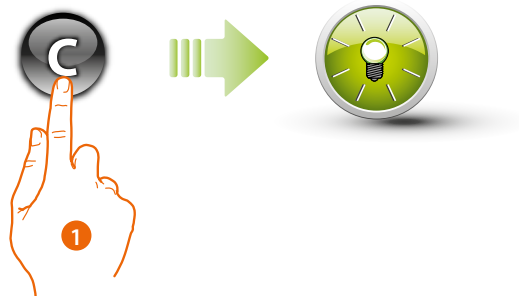

1. Press **C** until the green LED starts flashing.



2. Enter the resident code.

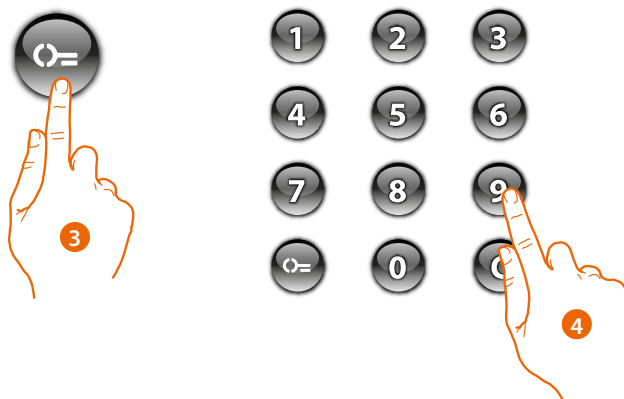

3. Press the **key icon**
4. Enter the **new code**

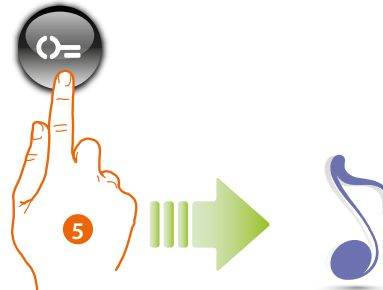

5. Press the  key
A short beep confirms the programming of the new resident code.

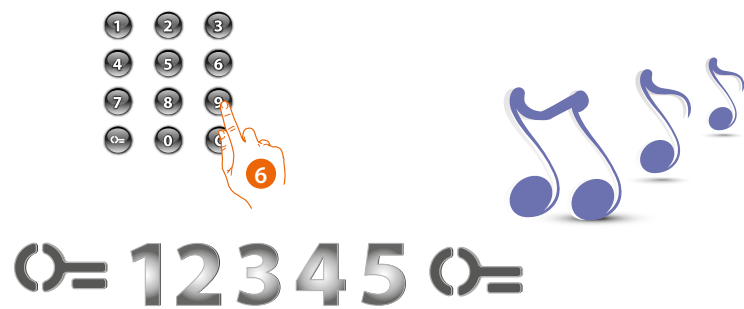

6. Enter the code again to confirm. The device emits a long confirmation beep.



If the procedure is successful, the green LED stays on for approximately 1 second and then switches off.



During the programming procedure, it will be necessary to follow some rules
Keys must be pressed in succession (with maximum 2 seconds in between pressures).
The programming sequence must start within 30 seconds from the pressure of the programming button and must be completed in one stage.

Reset

Should it become necessary to delete all the previously stored codes, it will be possible to reset the Sfera Keypad Module. After the reset, the module will be set to the default settings.

! **Caution: disconnect the power supply (BUS).**

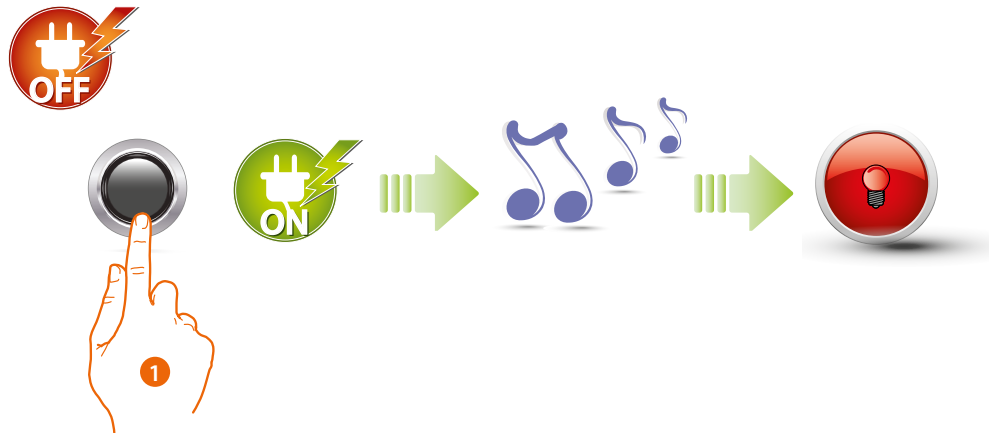

1. Keep the programming pushbutton pressed and reconnect the power supply, keeping the button pressed until a beep is heard. The red LED comes on steady for 4 seconds and then switches off.

! In case of entrance panels with keypad module and speaker module, after the reset wait at least 1 minute before restarting with the programming procedure.

Configuration using the software

Connection to the PC

To transfer the configuration performed using the TiSferaDesign software, or to update the firmware, connect the Sfera Keypad Module to the PC using a USB-miniUSB cable.

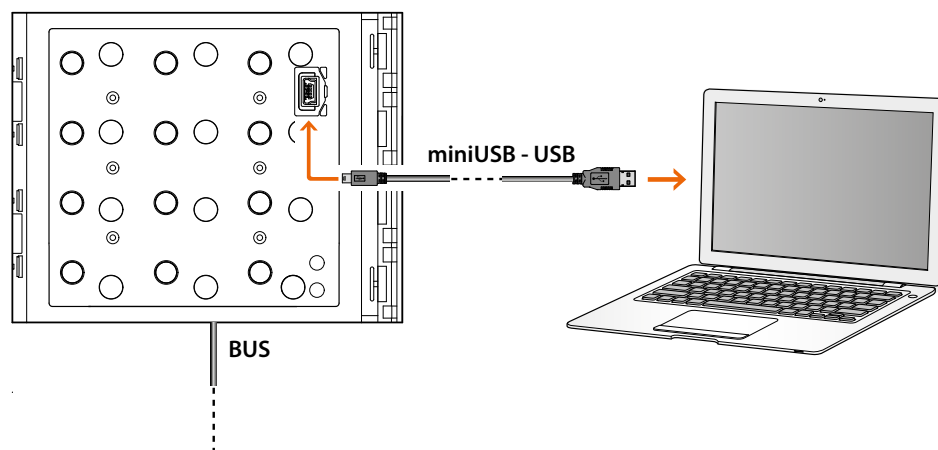

When updating the software the device must be powered.

The Sfera Keypad Module connected using a USB cable is recognised by the PC as a virtual port (VIRTUAL COM).

Sfera Keypad Module

User and installation manual

BTicino SpA
Viale Borri, 231
21100 Varese
www.bticino.com
