

SPOT SET ADJ

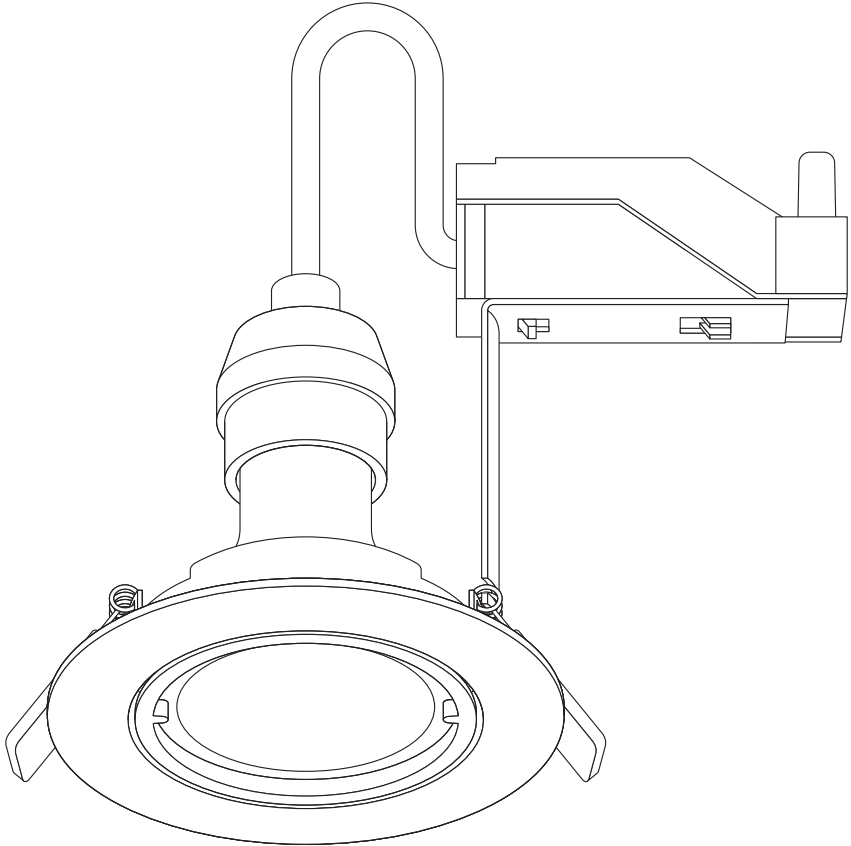

	EAN	W	Max. W	lm	K	IP	⊖ (°C)	V-	mA	Hz	PF
SP SET ADJ 4.3W 2700K 230V WT GU10	4058075572997	4.3	100	345	2700	20	-20...+40	220- 240	38	50/60	>0.4
SP SET ADJ 4.3W 2700K 230V BN GU10	4058075573017	4.3	100	345	2700	20	-20...+40	220- 240	38	50/60	>0.4

SPOT SET ADJ

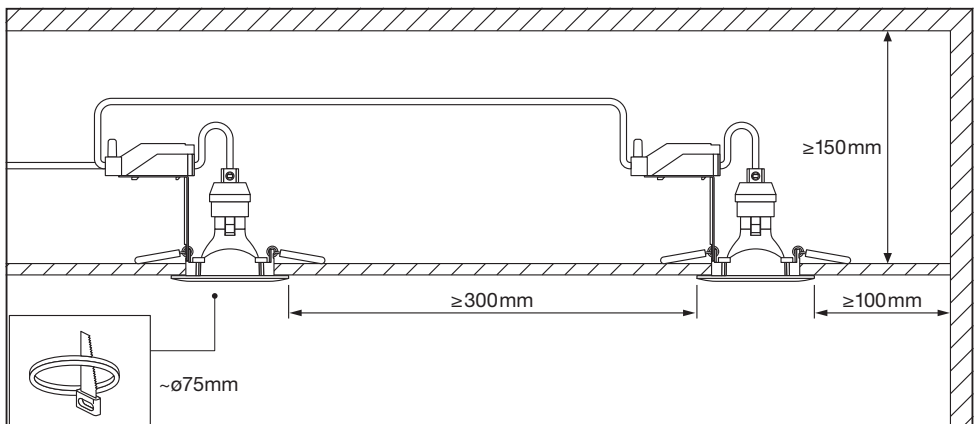
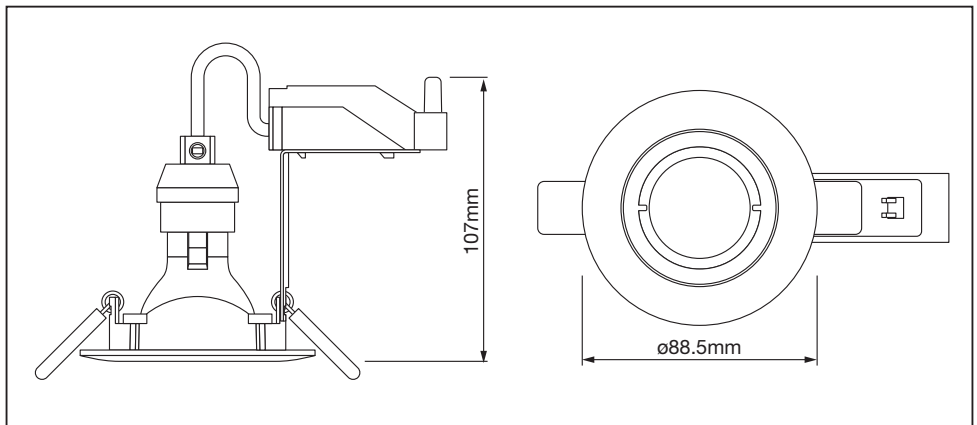
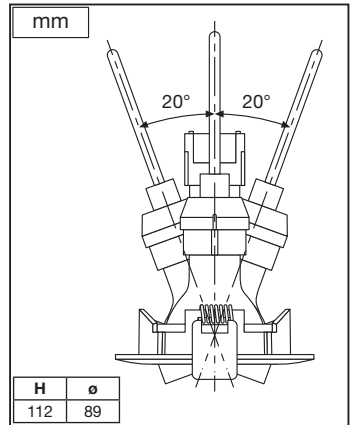
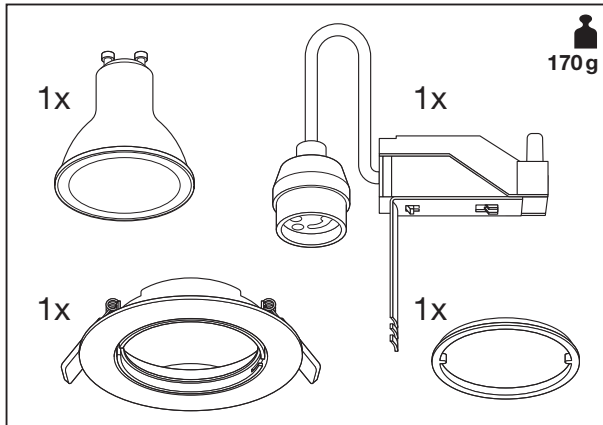
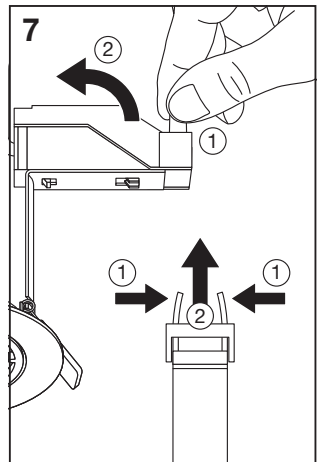
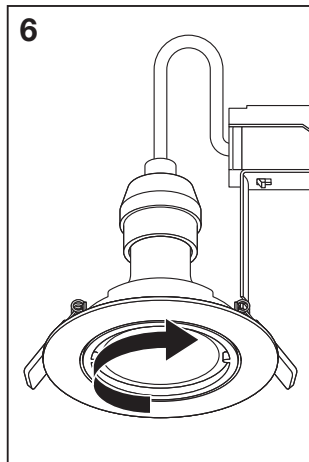
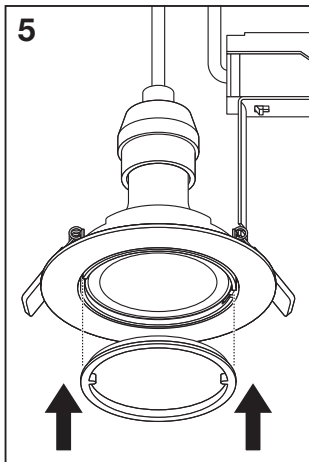
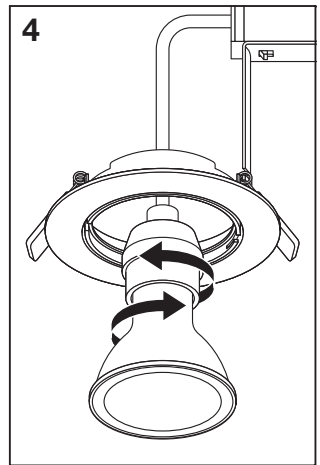
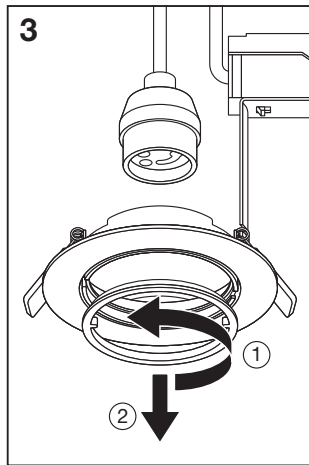
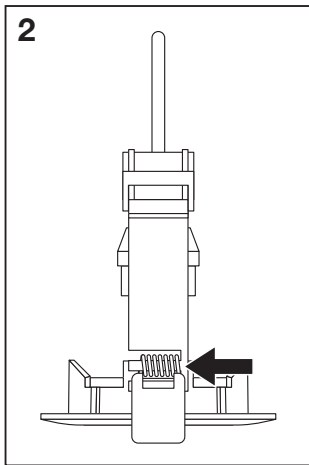
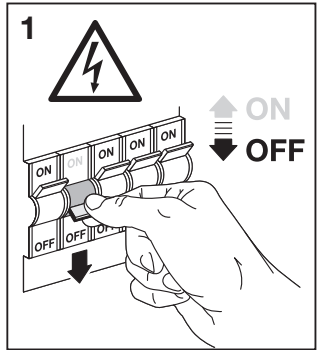
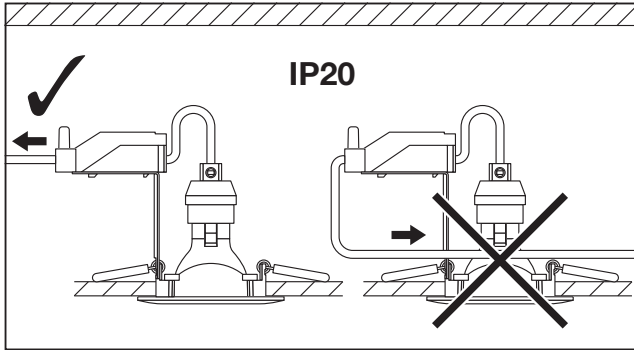



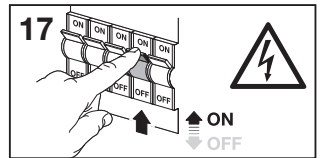
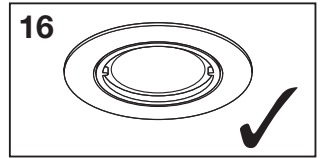
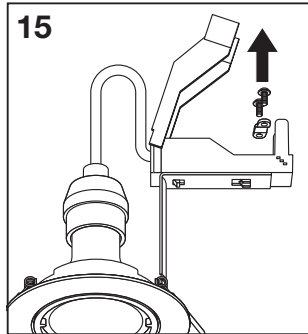
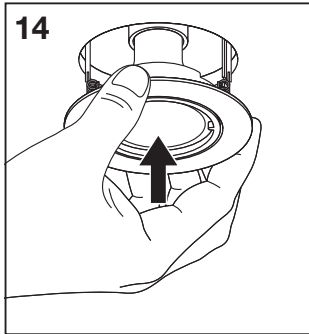
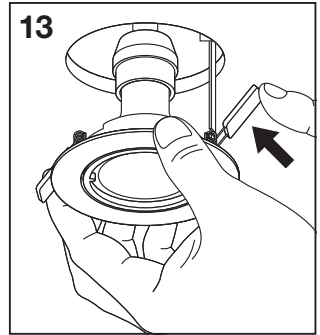
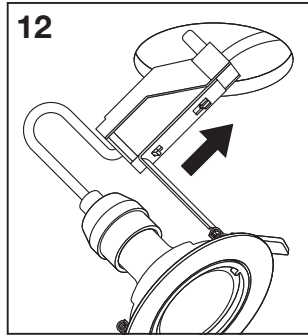
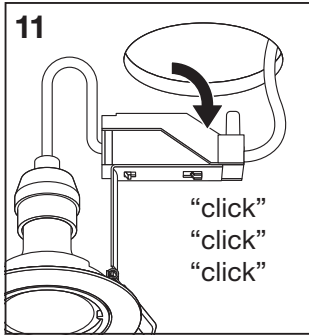
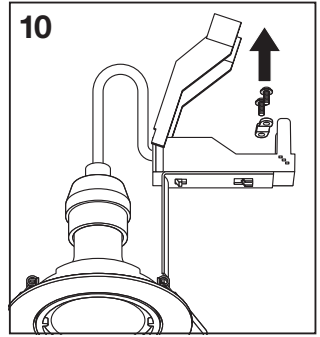
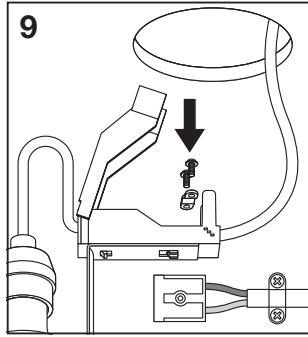
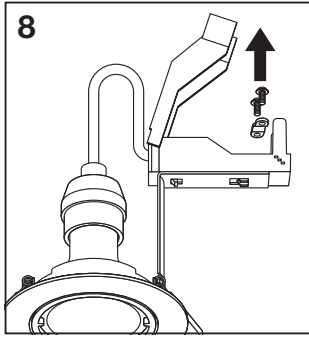

	EAN	This product contains a light source of energy efficiency class	Contained Light Source
SP SET ADJ 4.3W 2700K 230V WT GU10	4058075572997	F	
SP SET ADJ 4.3W 2700K 230V BN GU10	4058075573017		



C10449057
G11117429
08.06.2021



LEDVANCE GmbH
Steinerne Furt 62
86167 Augsburg, Germany
www.ledvance.com