

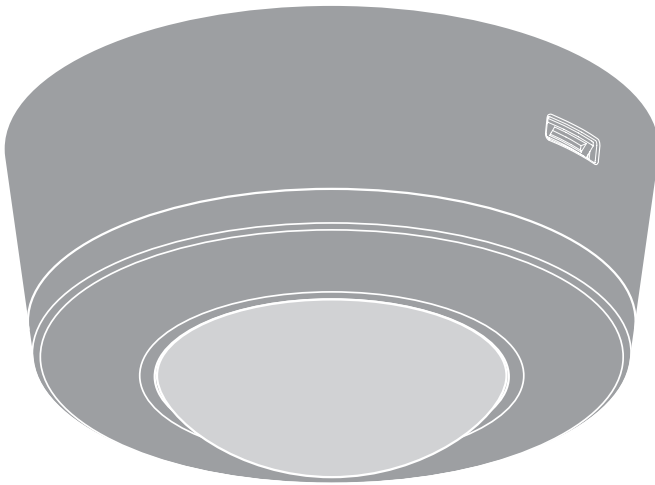

SENSOR CEILING



	EAN	ø x h [mm]	IP	IK	° (°C)	V _{AC}	Hz	
SENSOR CEILING 360DEG IP44 WT	4058075244719	92x50	44	05	-20...+40	220-240 V	50/60 Hz	0.117 kg



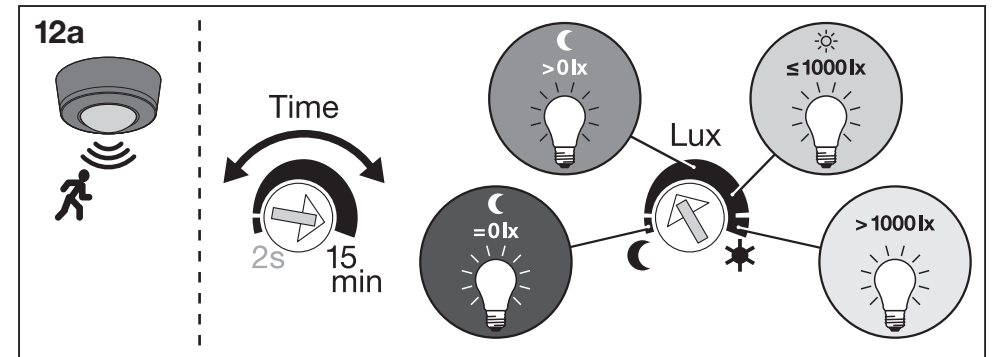
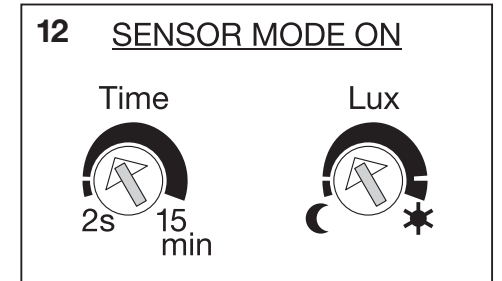
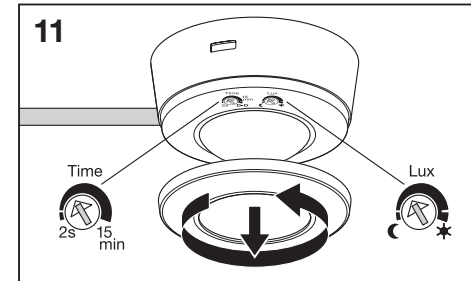
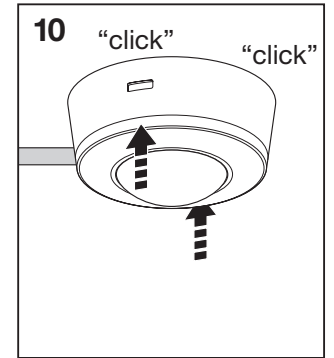
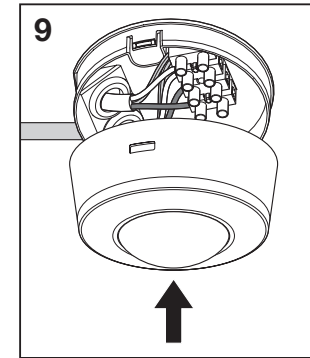
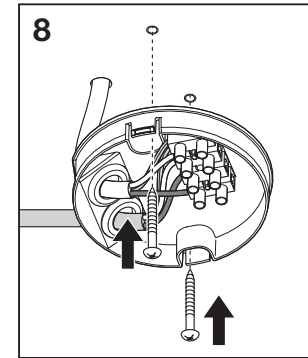
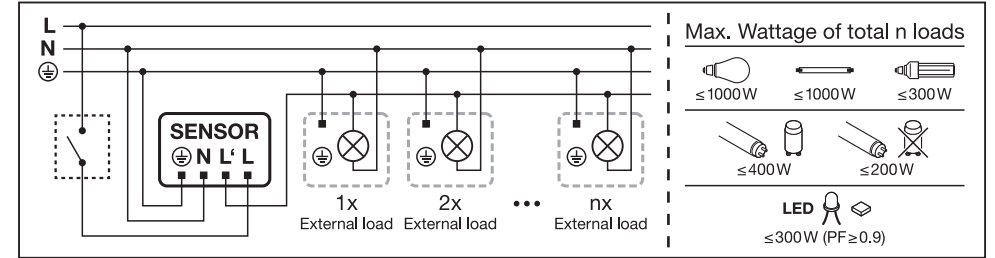
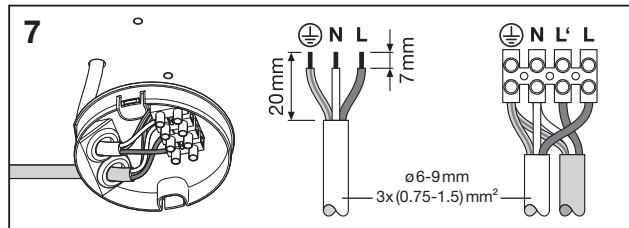
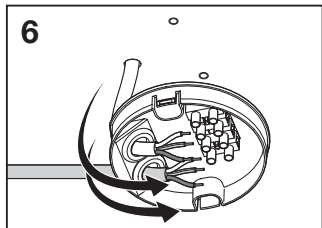
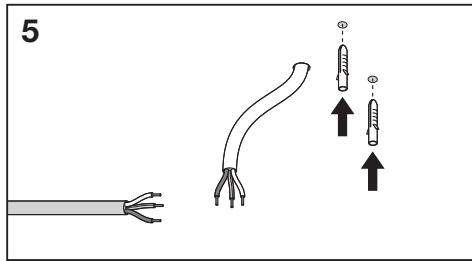
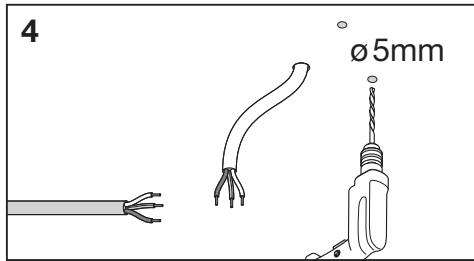
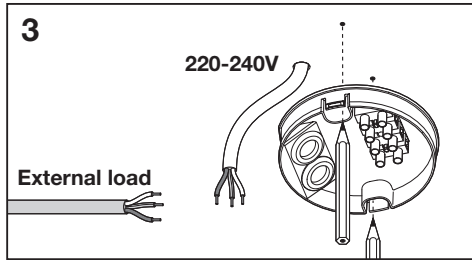
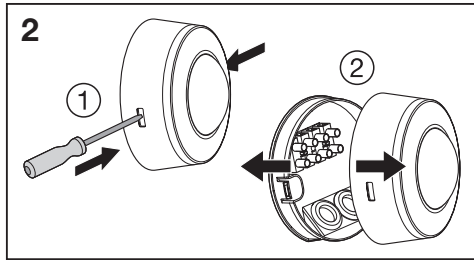
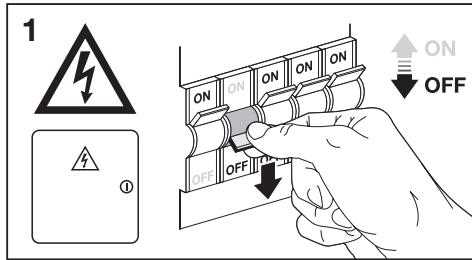
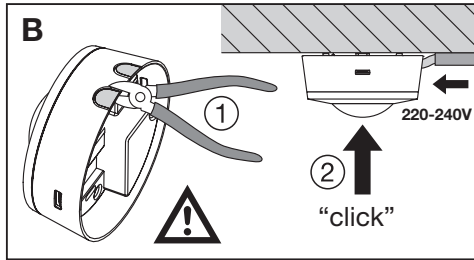
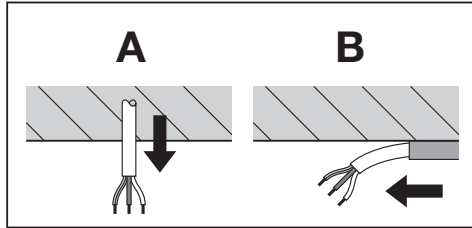
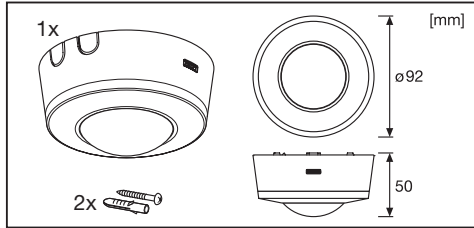
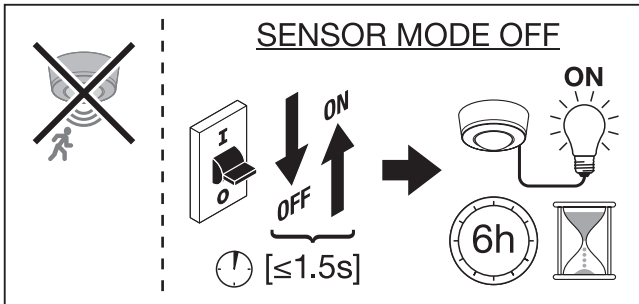
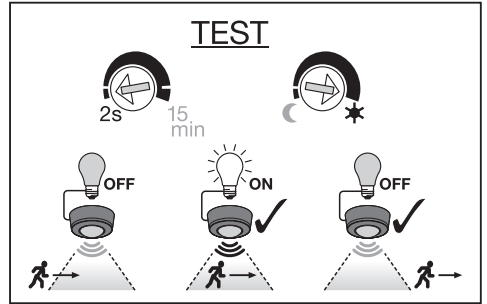
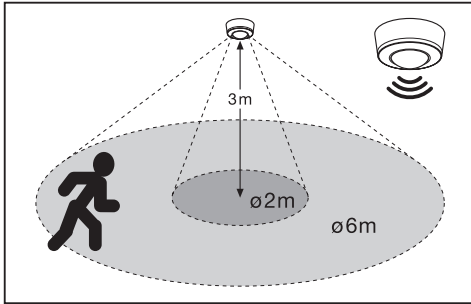
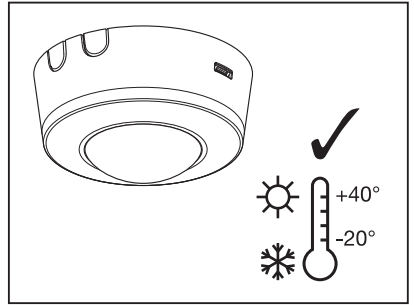
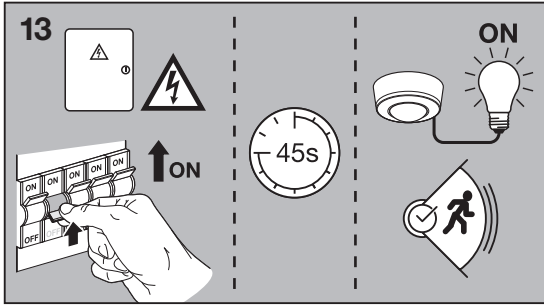

IP44 RoHS



C10449057
G11063277
05.02.19



LEDVANCE GmbH
Steinerne Furt 62
86167 Augsburg, Germany
www.ledvance.com