

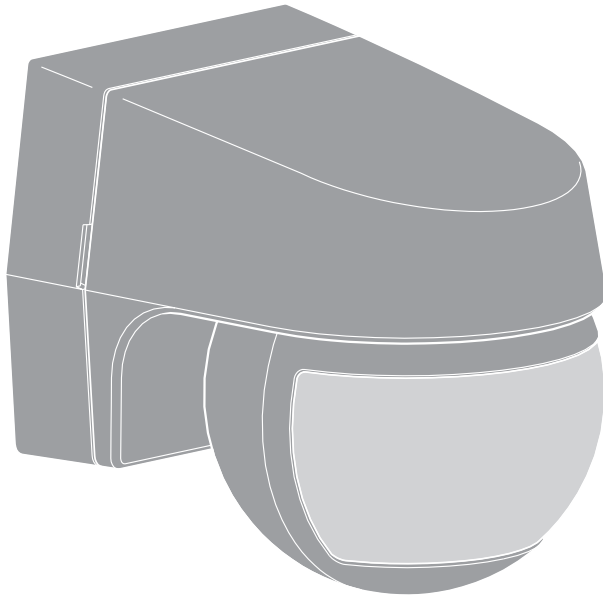

SENSOR WALL 110DEG



	EAN	l x w x h [mm]	IP	IK	°C	V _{AC}	Hz	
SENSOR WALL 110DEG IP44 WT	4058075244733	60x77x72	44	05	-10...+40	220-240V	50/60 Hz	0.089kg
SENSOR WALL 110DEG IP44 DG	4058075244757	60x77x72	44	05	-10...+40	220-240V	50/60 Hz	0.089kg



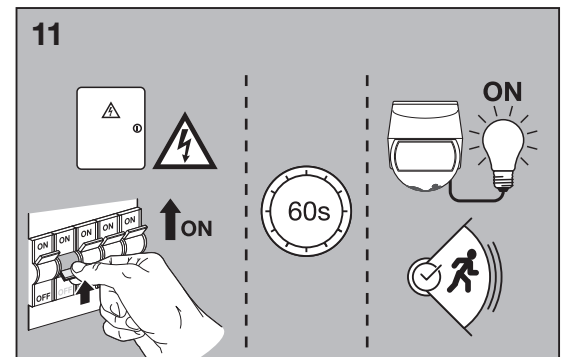
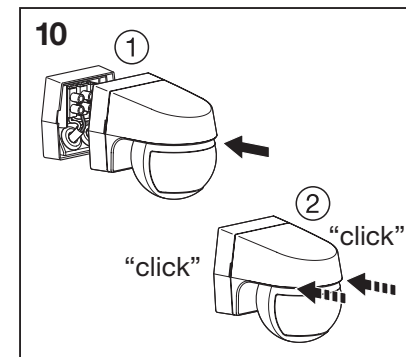
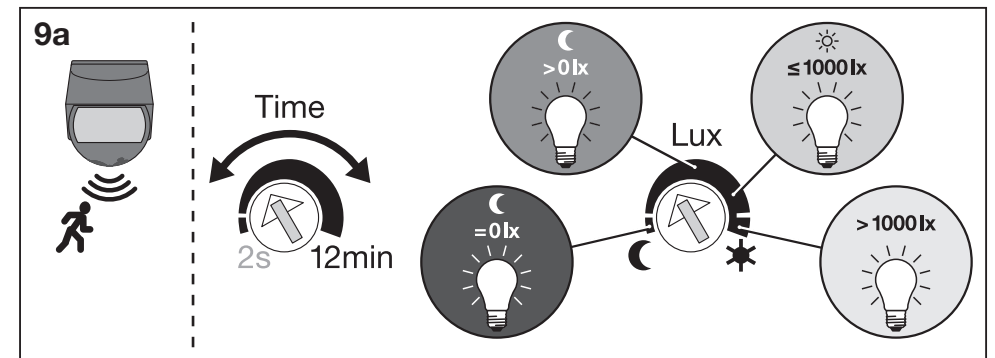
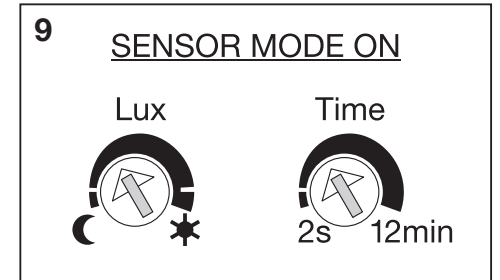
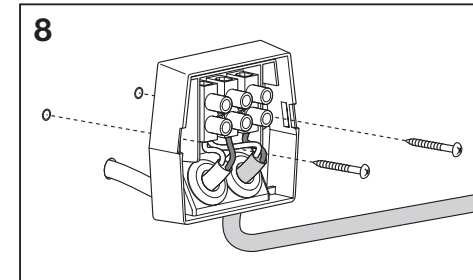
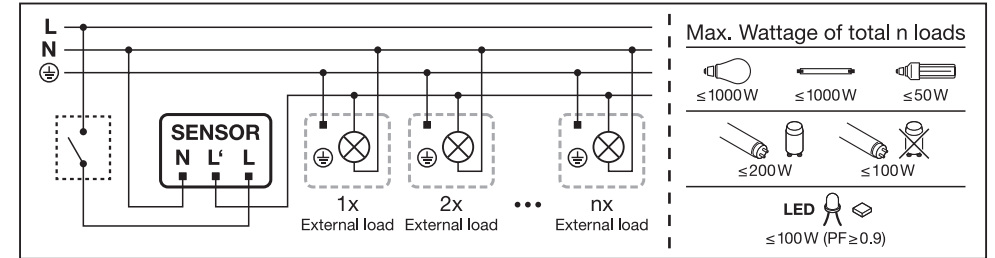
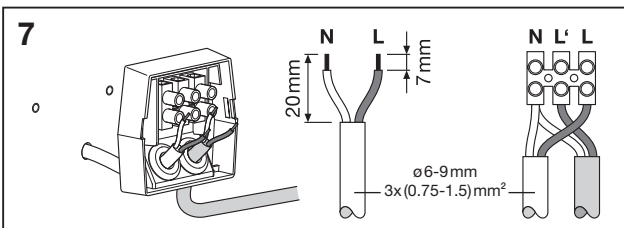
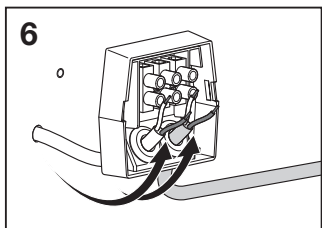
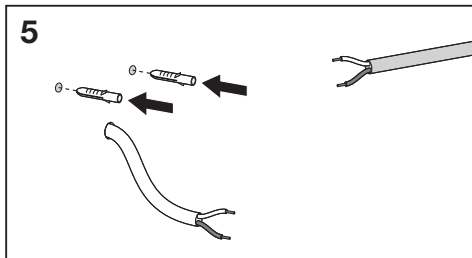
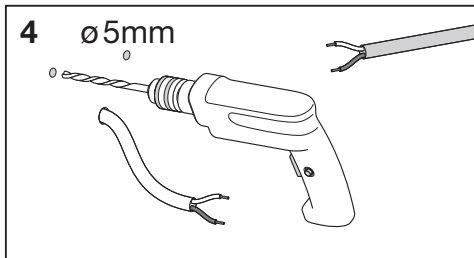
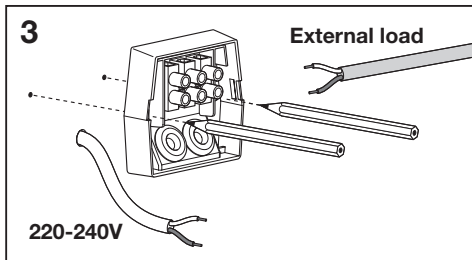
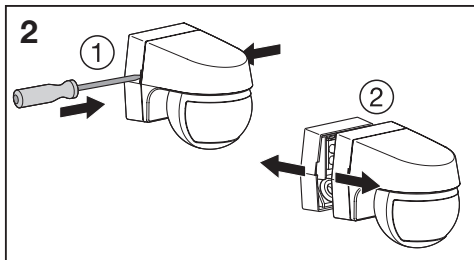
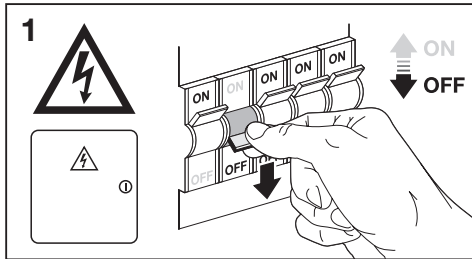
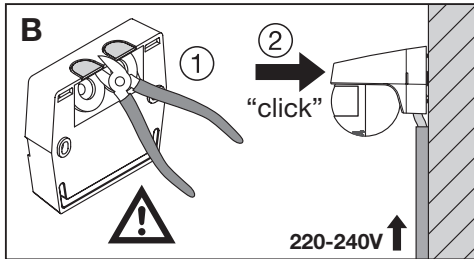
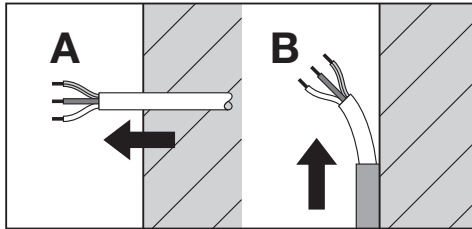
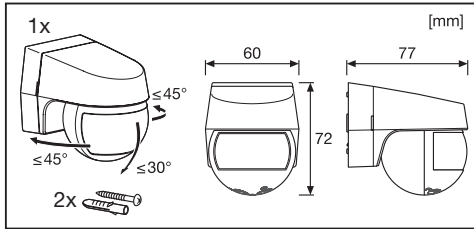
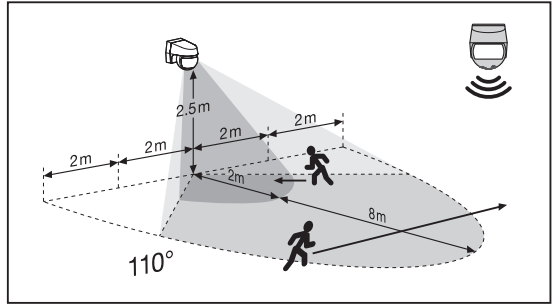
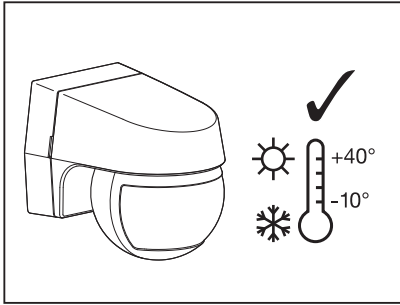

TEST

Lux Time

2s 12min

OFF ON OFF

IP44 RoHS



C10449057
G11063278
05.02.19



LEDVANCE GmbH
Steinerne Furt 62
86167 Augsburg, Germany
www.ledvance.com